

# Corner Robe

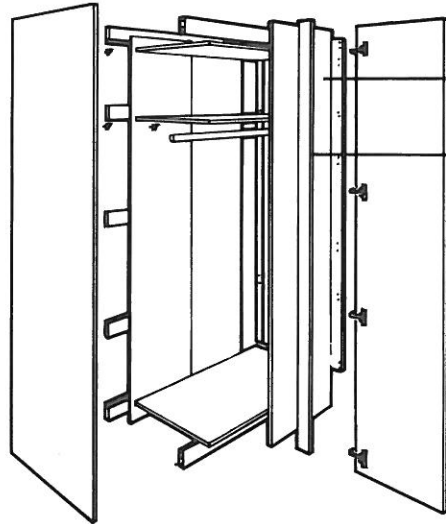

Code	Part	Qty
G	Blanking Panel	1
H	Corner Post	1

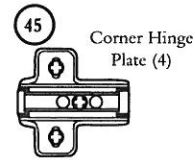
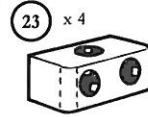
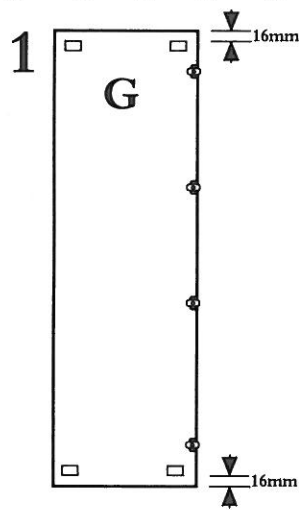
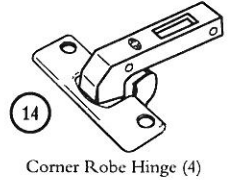
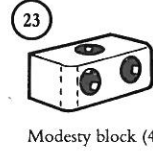

**Note:**  
Decide which side is to have Blanking Panel. Right handed Blanking Panel shown

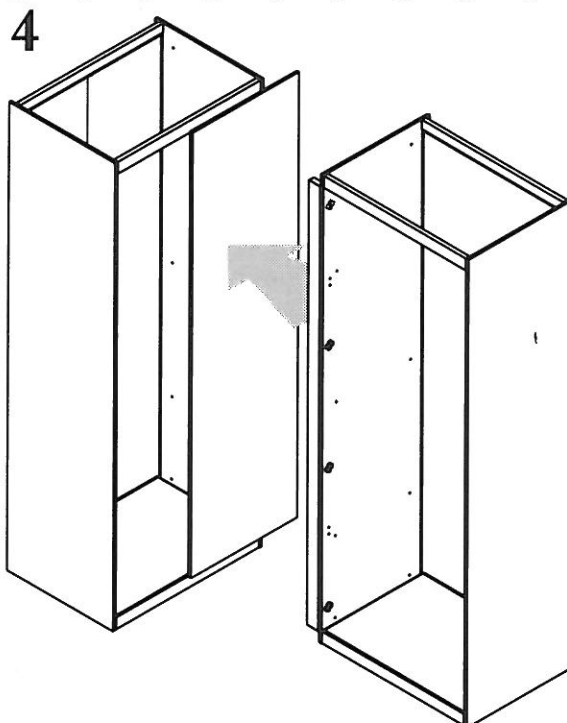
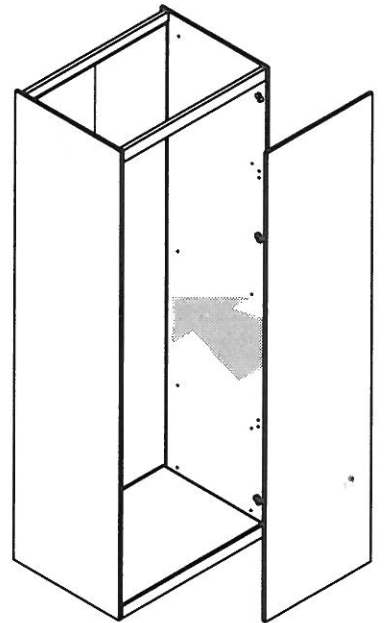

Bradawl holes for 4 Modesty Blocks in the Corner Post, 12mm from the front edge. Fit the Corner Post to the adjoining unit with Modesty Blocks and position both units in the corner.

The design of the blanking panel allows the corner arrangement to accommodate any obstructions

